

Data sheet | Item number: 831-3628/108-000

THT male header; 1.0 x 1.2 mm solder pin; angled; 100% protected against mismatching; Threaded flange; Pin spacing 7.62 mm; 8-pole; light gray

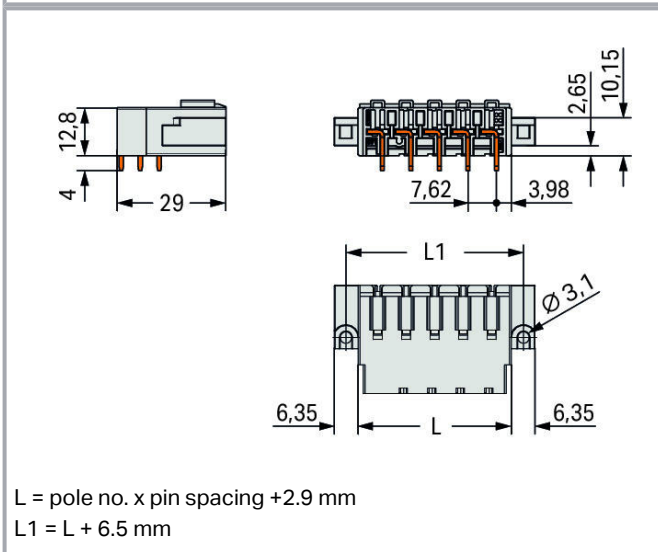

www.wago.com/831-3628_108-000

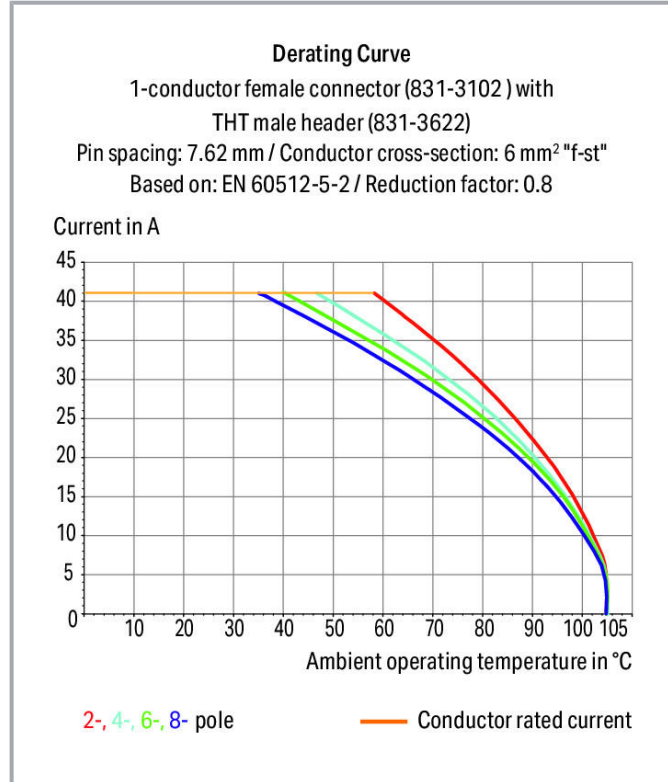
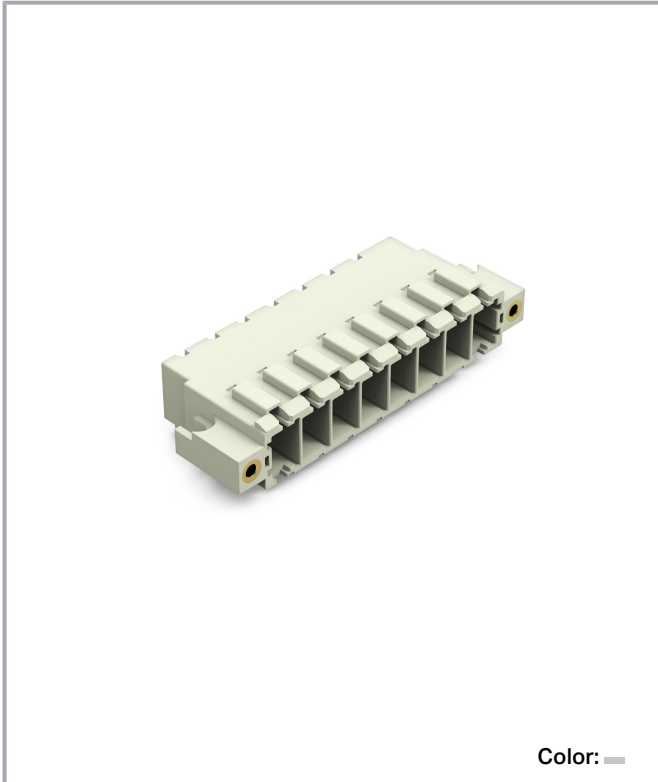

Subject to changes. Please also observe the further product documentation!

WAGO Corporation
Germantown, WI 53022
Phone: 1-800-DIN-RAIL (346-7245) | Fax: (262) 255-6222
Email: info.us@wago.com | Web: www.wago.us

Do you have any questions about our products?
We are always happy to take your call at (262) 255-6222 or 1 800-DIN-RAIL.



Item description

- Male headers may be mounted horizontally or vertically via straight or angled solder pins
- Three solder pins per pole provide high electrical and mechanical stability
- 100 % protected against mismatching
- Coding via coding fingers

Safety information 1:

The *MCS – MULTI CONNECTION SYSTEM* includes connectors without breaking capacity in accordance with DIN EN 61984. When used as intended, these connectors must not be connected/disconnected when live or under load. The circuit design should ensure header pins, which can be touched, are not live when unmated.

Data

Electrical data

IEC Approvals

Ratings per	IEC/EN 60664-1
Rated voltage (III / 3)	500 V
Rated surge voltage (III/3)	6 kV
Rated voltage (III/2)	630 V
Rated surge voltage (III/2)	6 kV
Nominal voltage (II/2)	1000 V
Rated surge voltage (II/2)	6 kV
Rated current	41 A
Legend (ratings)	(III / 2) $\hat{=}$ Overvoltage category III / Pollution degree 2

UL Approvals

Approvals per	UL 1059
Rated voltage UL (Use Group C)	300 V
Rated current UL (Use Group C)	42 A
Rated voltage UL (Use Group D)	600 V
Rated current UL (Use Group D)	5 A

CSA Approvals

Approvals per	CSA
Rated voltage CSA (Use Group C)	300 V
Rated current CSA (Use Group C)	41 A
Rated voltage CSA (Use Group D)	600 V

Subject to changes. Please also observe the further product documentation!

WAGO Corporation
 Germantown, WI 53022
 Phone: 1-800-DIN-RAIL (346-7245) | Fax: (262) 255-6222
 Email: info.us@wago.com | Web: www.wago.us

Do you have any questions about our products?
 We are always happy to take your call at (262) 255-6222 or 1 800-DIN-RAIL.



Rated current CSA (Use Group D)	5 A
---------------------------------	-----

Connection data

Pole No.	8
Total number of potentials	8
Number of connection types	1
Number of levels	1

Physical data

Pin spacing	7.62 mm / 0.3 inch
Width	76.6 mm / 3.014 inch
Height	18.8 mm / 0.74 inch
Height from the surface	14.8 mm / 0.583 inch
Depth	29 mm / 1.142 inch
Solder pin length	4 mm
Solder pin dimensions	1 x 1.2 mm
Drilled hole diameter with tolerance	1.7 ^(+0.1) mm

Plug-in connection

Contact type (pluggable connector)	Male header
Connector (connection type)	for PCB
Mismating protection	Yes
Mating direction to the PCB	0°
Locking of plug-in connection	Threaded flange

PCB contact

PCB Contact	THT
Solder pin arrangement	over the entire male connector (in-line)
Number of solder pins per potential	3

Material data

Color	light gray
Material group	I
Insulation material	Polyamide (PA66)
Flammability class per UL94	V0
Contact material	

Subject to changes. Please also observe the further product documentation!

WAGO Corporation
 Germantown, WI 53022
 Phone: 1-800-DIN-RAIL (346-7245) | Fax: (262) 255-6222
 Email: info.us@wago.com | Web: www.wago.us

Do you have any questions about our products?
 We are always happy to take your call at (262) 255-6222 or 1 800-DIN-RAIL.

Electrolytic copper (E_{Cu})

Contact plating	tin-plated
Weight	23.5 g

Environmental requirements

Limit temperature range	-60 ... +105 °C
-------------------------	-----------------

Commercial data

Packaging type	BOX
Country of origin	PL
GTIN	4055144036961
Customs tariff number	8536694040

Approvals / Certificates

Country specific Approvals

Logo	Approval	Additional Approval Text	Certificate name
	CB DEKRA Certification B.V.	IEC 61984	NL-61360 /M1
	KEMA/KEUR DEKRA Certification B.V.	EN 61984	71-116057

Counterpart



Item no.831-3108/107-000

1-conductor female connector; 100% protected against mismatching; Screw flange; 10 mm²; Pin spacing 7.62 mm; 8-pole; 10,00 mm²; light graywww.wago.com/831-3108/107-000

Downloads

Documentation

Additional Information

Technical explanations	Apr 3, 2019	pdf 2.0 MB	Download
------------------------	-------------	---------------	----------

Subject to changes. Please also observe the further product documentation!

Environmental Product Compliance

Compliance Search

Environmental Product Compliance 831-3628/108-000

[URL](#)

[Download](#)

THT male header; 1.0 x 1.2 mm solder pin; angled; 100% protected against mismatching; Threaded flange; Pin spacing 7.62 mm; 8-pole; light gray

Installation Notes

Coding

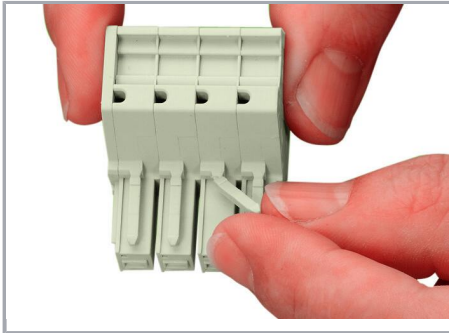

Break or cut off coding pin from female connector.

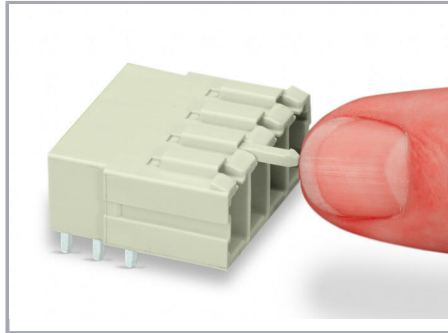

Insert coding pin into male header (break first) until it engages.

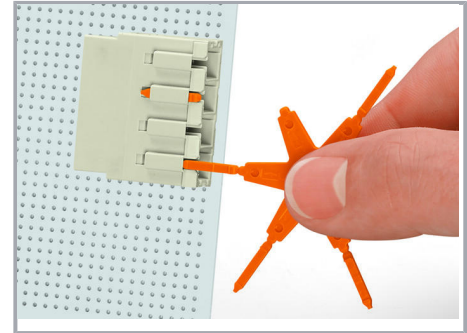

Coding a THT male header by inserting a coding pin.

Product family

[*MCS* MAXI 6](#)

[Show all products from the family](#)

Subject to changes. Please also observe the further product documentation!